

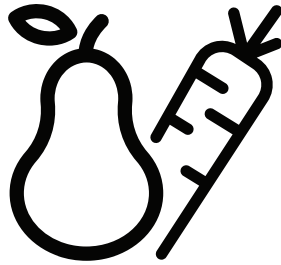

**Refrigerator**  
User Manual



270560EBC - 270560ESC - 270560EI  
270560EB - 270560EA - 270561EA - 270561ESC  
270561EB - 270514EI-DUMMY PANGEA



**Dear Customer,**  
**Please read this user manual before using the product.**

Thank you for preferring this product. We hope that you get the best results from your product which has been manufactured with high quality and state-of-the-art technology.. Therefore, please read this entire user manual and all other accompanying documents before using the product. Follow all warnings and information in the user manual. Thus, you can protect yourself and your product against potential dangers. Keep the user manual. If you handover the product to someone else, give the user manual as well.





The following symbols are used throughout this user manual:

 Danger that may result in death or injury.









**NOTICE** Danger that may result in damage to the product or its surroundings.

 Important information or useful hints about usage.

 Read the user manual.

 <b>INFORMATION</b>	
 <b>SUPPLIER'S NAME</b> <b>MODEL IDENTIFIER</b> → (*)  	The model information as stored in the product data base can be reached by entering following website and searching for your model identifier (*) found on energy label. <a href="https://eprel.ec.europa.eu/">https://eprel.ec.europa.eu/</a>

## **1 Safety Instructions 3**

 1.1 Intended Use . . . . .	3
 1.2 – Safety for children, vulnerable persons and pets . . . . .	3
 1.3 – Electrical safety . . . . .	4
 1.4 – Transportation safety . . . . .	4
 1.5 – Installation safety . . . . .	4
 1.6– Operational safety . . . . .	5
 1.7– Maintenance and cleaning safety . . . . .	7
 1.8– HomeWhiz . . . . .	7
 1.9– Lighting . . . . .	7

## **2 Environment instructions 8**

## **3 Your Refrigerator 9**

## **4 Installation 10**

4.1. Right place for installation . . . . .	10
4.2. Adjusting the stands . . . . .	10
4.3. Power connection . . . . .	11
4.4 Attaching the plastic wedges . . . . .	11

## **5 Preparation 12**

5.1. What to do for energy saving . . . . .	12
5.2. First Use . . . . .	12

## **6 Using the product 14**

6.1. Indicator panel . . . . .	14
6.2. Ice bucket . . . . .	17
6.3. Eggholder . . . . .	17
6.4. Fan . . . . .	17
6.5. Vegetable bin . . . . .	17

6.6. Using the second crisper of the product . . . . .	18
6.7. Zero degree compartment . . . . .	19
6.8. Sliding storage box . . . . .	19
6.9. Moving door rack . . . . .	19
6.10. Moisture controlled vegetable bin . . . . .	20
6.11. Deodoriser Module . . . . .	20
6.12. Automatic ice machine . . . . .	21
6.13. Icematic and ice storage container . . . . .	22
6.14. Ice bucket . . . . .	22
6.15. Using the water dispenser . . . . .	23
6.16. Filling the water dispenser's tank . . . . .	24
6.17. Cleaning the water tank . . . . .	25
6.18. Drip tray . . . . .	25
6.19. HerbBox/HerbFresh . . . . .	25
6.20. Freezing fresh food . . . . .	26
6.21. Recommendations for storing frozen foods . . . . .	26
6.22. Deep freezer details . . . . .	27
6.23. Placing the food . . . . .	27
6.24. Door open alert . . . . .	27
6.25. Changing the opening direction of the door . . . . .	27
6.26. Interior light . . . . .	27
6.27. Blue light/VitaminZone . . . . .	28

## **7 Care and Cleaning 29**

7.1. Avoiding Bad Odours . . . . .	29
7.2. Protection of plastic surfaces . . . . .	29
7.3. Cleaning the Inner Surface . . . . .	29
7.4. Stainless Steel Outer Surfaces . . . . .	30
7.5. Cleaning Products with Glass Doors . . . . .	30

## **8 Troubleshooting 31**

# 1 Safety Instructions

- This section contains safety instructions that will help get protected against risks of personal injury or property damage.
- Our company shall not be responsible for damages that may arise when these instructions are not followed.

 Installation and repair procedures must always be performed by the manufacturer, authorised service agent or a qualified person specified by the importer.

 Only use original parts and accessories.

 Do not repair or replace any part of the product unless specified expressly in the user manual.

 Do not make any technical modifications to the product.

## 1.1 Intended Use

- This product is not suitable for commercial use and it must not be used out of its intended use.

This product is designed to be used in houses and indoor places.

For example:

- Personnel kitchens in stores, offices and other working environments,
- Farm houses,
- Areas used by customers at hotels, motels and other types of accommodation,
- Bed&breakfast type hotels, boardinghouses,
- Catering and similar non-retail applications.

This product should not be used outdoors with or without a tent above it such as boats, balconies or terraces. Do not expose the product to rain, snow, sun or wind.

There is the risk of fire!

## 1.2 - Safety for children, vulnerable persons and pets

- This product can be used by children 8 years of age and older as long as they are supervised or trained about the safe use and hazards of the product; it is not intended for use by persons who are underdeveloped in physical, sensory or mental skills, or who lack of experience and knowledge.
- Children aged from 3 to 8 years are allowed to load and unload refrigerating products.
- Electrical products are dangerous for children and pets. Children and pets must not play with, climb or enter the product.
- Cleaning and user maintenance should not be performed by children unless they are supervised by someone.
- Keep packaging materials away from children. There is the risk of injury and suffocation!
- Before disposing of the old or obsolete product:
  1. Unplug the product by gripping from the plug.
  2. Cut the power cable and remove it from the appliance together with its plug
  3. Do not remove the shelves or drawers so that it is harder for children to enter the product.
  4. Remove the doors.
  5. Keep the product in a way that it will not tip over.
  6. Do not allow children play with the old product.
- Never throw the product into fire for disposal. There is the risk of explosion!
- If there is a lock on the door of the product, the key should be kept out of the reach of children.

## Safety instructions

### **1.3 - Electrical safety**

- The product must be unplugged during installation, maintenance, cleaning, repairing and moving procedures.
- If the power cable is damaged, it must be replaced by a qualified person specified by the manufacturer, authorised service agent or importer in order to avoid potential dangers.
- Do not squeeze the power cable under or behind the product. Do not place heavy objects on the power cable. Power cable must not be bent excessively, pinched or get in contact with any heat source.
- Do not use extension cords, multi-sockets or adapters to operate the product.
- Portable multi-sockets or portable power sources can overheat and cause fire. Therefore, do not keep any multi-sockets behind or near the product.
- Plug must be easily accessible. If this is not possible, the electrical installation to which the product is connected must contain a device (such as a fuse, switch, circuit breaker, etc.) which conforms to the electrical regulations and disconnects all poles from the grid.
- Do not touch the power plug with wet hands.
- Remove the plug from the socket by gripping the plug and not the cable.

### **1.4 - Transportation safety**

- Product is heavy; do not move it alone.
- Do not hold its door when moving the product.

- Pay attention not to damage the cooling system or the piping during transportation. If the piping is damaged, do not operate the product and call the authorised service agent.

### **1.5 - Installation safety**

- Call the authorised service agent for installation of the product. To make the product ready for use, check the information in the user manual to make sure that the electricity and water installations are suitable. If they are not, call a qualified electrician and plumber to have the necessary arrangements made. Otherwise, there is the risk of electric shock, fire, problems with the product, or injury!
- Prior to installation, check if the product has any defects on it. If the product is damaged, do not have it installed.
- Place the product on a clean, flat and solid surface and balance it with adjustable feet. Otherwise, the product may tip over and cause injuries.
- The installation location must be dry and well ventilated. Do not place carpets, rugs or similar covers under the product. Insufficient ventilation causes the risk of fire!
- Do not cover or block the ventilation openings. Otherwise, power consumption increases and your product may get damaged.
- Product must not be connected to supply systems such as solar power supplies. Otherwise, your product may get damaged due to sudden voltage changes!

## Safety instructions

- The more refrigerant a refrigerator contains, the larger the installation location must be. If the installation location is too small, flammable refrigerant and air mixture will accumulate in cases of refrigerant leakage in cooling system. The required space for each 8 gr of refrigerant is 1 m<sup>3</sup> minimum. The amount of refrigerant in your product is indicated on the Type Label.
  - Product must not be installed in places exposed to direct sunlight and it must be kept away from heat sources such as hobs, radiators, etc.
- If it is inevitable to install the product close to a heat source, a suitable insulation plate must be used in between and the following minimum distances must be kept to the heat source:
- Minimum 30 cm away from heat sources such as hobs, ovens, heater units or stoves,
  - Minimum 5 cm away from electric ovens.
- Protection class of your product is Type I. Plug the product in a grounded socket that conforms the voltage, current and frequency values stated on the type label of the product. The socket must be equipped with a 10 A – 16 A circuit breaker. Our company shall not be liable for any damages that will arise when the product is used without grounding and electrical connection in accordance with the local and national regulations.
  - Product must not be plugged in during installation. Otherwise, there is the risk of electric shock and injury!
  - Do not plug the product in sockets that are loose, dislocated, broken, dirty, greasy or bear the risk of getting in contact with water.
  - Route the power cable and hoses (if any) of the product in a way that they do not cause risk of tripping over.
  - Exposing the live parts or power cable to humidity may cause short circuit. Therefore, do not install the product in places such as garages or laundry rooms where humidity is high or water may splash. If the refrigerator gets wet with water, unplug it and call the authorised service agent.
  - Never connect your refrigerator to energy saving devices. Such systems are harmful to your product.

### **1.6- Operational safety**

- Never use chemical solvents on the product. There is the risk of explosion!
- If the product malfunctions, unplug it and do not operate until it is repaired by the authorised service agent. There is the risk of electric shock!
- Do not place flame sources (lit candles, cigarettes, etc.) on or close to the product.
- Do not climb on the product. There is the risk of falling and getting injured!
- Do not damage the pipes of the cooling system with sharp or penetrating objects. The refrigerant that might come out when the refrigerant pipes, pipe extensions or surface coatings are punctured causes skin irritations and eye injuries.
- Unless recommended by the manufacturer, do not place or use electrical devices inside the refrigerator/deep freezer.

## Safety instructions

- Be careful not to trap your hands or any other part of your body in the moving parts inside the refrigerator. Pay attention not to squeeze your fingers between the door and the refrigerator. Be careful when opening and closing the door particularly if there are children around.
- Never eat ice cream, ice cubes or frozen food right after removing them from the refrigerator. There is the risk of frostbite!
- When your hands are wet, do not touch the inner walls or metal parts of the freezer or the food stored therein. There is the risk of frostbite!
- Do not place tins or bottles that contain carbonated drinks or freezable liquids in the freezer compartment. Tins and bottles may burst. There is the risk of injury and material damage!
- Do not place or use flammable sprays, flammable materials, dry ice, chemical substances or similar heat-sensitive materials near the refrigerator. There is the risk of fire and explosion!
- Do not store explosive materials that contain flammable materials, such as aerosol cans, in your product.
- Do not place containers filled with liquid onto the product. Splashing water on an electrical part may cause electric shock or the risk of fire.
- This product is not intended for storing medicines, blood plasma, laboratory preparations or similar medical substances and products subject to Medical Products Directive.
- Using the product against its intended purpose may cause the products stored inside it to deteriorate or spoil.
- If your refrigerator is equipped with blue light, do not look at this light with optical tools. Do not stare at UV LED lamp directly for a long time. Ultraviolet light may cause eye strain.
- Do not overload the product. Objects in the refrigerator may fall down when the door is opened, causing injury or damage. Similar problems may arise if any object is placed onto the product.
- To avoid injuries, make sure that you have cleaned all the ice and water that may have fallen or splashed on the floor.
- Change the position of the shelves/ bottle holders on the door of your refrigerator only when they are empty. There is the risk of injury!
- Do not place objects that can fall down/tip over onto the product. Such objects may fall down when the door is opened and cause injuries and/or material damage.
- Do not hit or exert excessive force on glass surfaces. Broken glass may cause injuries and/or material damage.
- Cooling system of your product contains R600a refrigerant: Type of the refrigerant used in the product is indicated on the type label. This refrigerant is flammable. Therefore, pay attention not to damage the cooling system or the piping while the product is in use. If the piping is damaged:
  - Do not touch the product or the power cable,
  - Keep away potential sources of fire that may cause the product to catch fire.
  - Ventilate the area where the product is located. Do not use fans.
  - Call the authorised service agent.

## Safety instructions

- If the product is damaged and you see refrigerant leak, please stay away from the refrigerant. Refrigerant may cause frostbite in case of skin contact.

### For products with a Water Dispenser/Ice Machine

- Use only potable water. Do not fill the water tank with any liquids –such as fruit juice, milk, carbonated beverages or alcoholic drinks– that are not suitable for use in the water dispenser.
- There is the risk for health and safety!
- Do not allow children play with the water dispenser or ice machine (Icematic) in order to prevent accidents or injuries.
- Do not insert your fingers or other objects into the water dispenser hole, water channel or ice machine container. There is the risk of injury or material damage!

### 1.7- Maintenance and cleaning safety

- Do not pull from the door handle if you need to move the product for cleaning purposes. Handle may break and cause injuries if you exert excessive force on it.
- Do not spray or pour water on or inside the product for cleaning purposes. There is the risk of fire and electric shock!
- Do not use sharp or abrasive tools when cleaning the product. Do not use household cleaning products, detergent, gas, gasoline, thinner, alcohol, varnish etc.

- Only use cleaning and maintenance products inside the product that are not harmful for food.
- Never use steam or steam assisted cleaners to clean or defrost the product. Steam gets into contact with the live parts in your refrigerator, causing short circuit or electric shock!
- Make sure that no water enters the electronic circuits or lighting elements of the product.
- Use a clean and dry cloth to wipe the foreign materials or dust on the pins of the plug. Do not use a wet or damp cloth to clean the plug. There is the risk of fire and electric shock!

### 1.8- HomeWhiz

- When you operate your product through HomeWhiz application, you must observe the safety warnings even when you are away from the product. You must also follow the warnings in the application.

### 1.9- Lighting

- Call the authorised service when it is required to replace the LED/bulb used for lighting.



## 2 Environment instructions

### 2.1 Compliance with the WEEE Directive and Disposing of the Waste Product:

This product complies with EU WEEE Directive (2012/19/EU). This product bears a classification symbol for waste electrical and electronic equipment (WEEE).



This symbol indicates that this product shall not be disposed with other household wastes at the end of its service life. Used device must be returned to official collection

point for recycling of electrical and electronic devices. To find these collection systems please contact to your local authorities or retailer where the product was purchased. Each household performs important role in recovering and recycling of old appliance. Appropriate disposal of used appliance helps prevent potential negative consequences for the environment and human health.

### 2.2 Compliance with RoHS Directive

The product you have purchased complies with EU RoHS Directive (2011/65/EU). It does not contain harmful and prohibited materials specified in the Directive.

### 2.3 Package information



Packaging materials of the product are manufactured from recyclable materials in accordance with our National Environment Regulations.

Do not dispose of the packaging materials together with the domestic or other wastes. Take them to the packaging material collection points designated by the local authorities.

### 3 Your Refrigerator

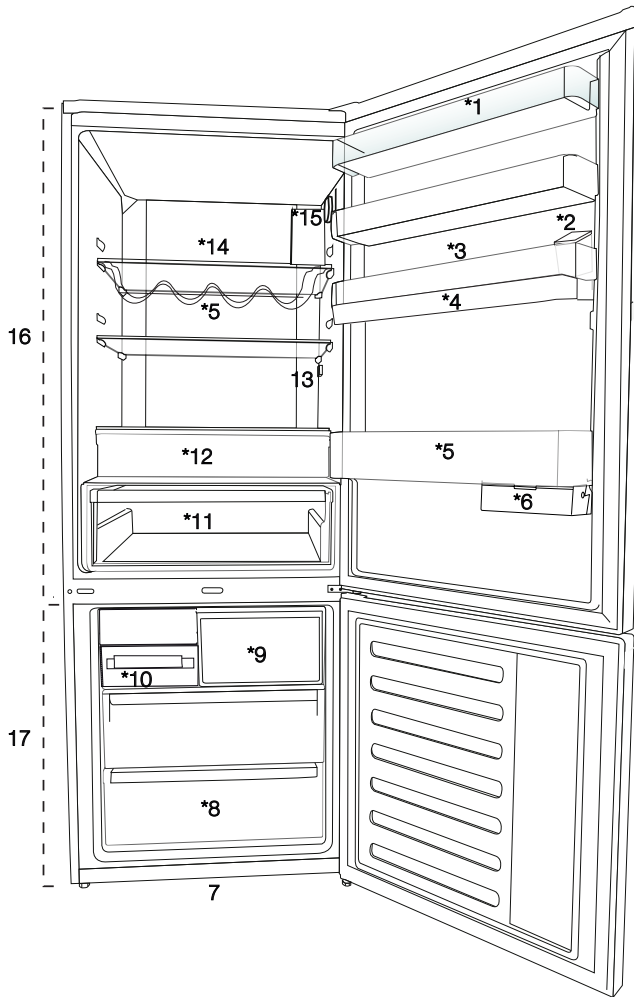

1. Cooler compartment door shelf
2. Water dispenser filling tank
3. Egg section
4. Water dispenser reservoir
5. Bottle shelf
6. Sliding storage box
7. Adjustable legs
8. Deep freezer compartment
9. Quick freeze compartment
10. Ice cube tray & Ice bank
11. Vegetable bin
12. Zero degree compartment
13. Interior light
14. Cooler compartment glass shelf
15. Temperature adjustment button
16. Cooler compartment
17. Freezer compartment

**May not be available in all models**



**\*optional:** Pictures given in this manual are given as example figures and they may not be exactly the same as your product. If your product does not comprise the relevant parts, the information pertains to other models.

## 4 Installation

 Read the “Safety Instructions” section first!

### 4.1. Right place for installation

Contact the Authorized Service for the product's installation. To ready the product for installation, see the information in the user guide and make sure the electric and water utilities are as required. If not, call an electrician and plumber to arrange the utilities as necessary.



**WARNING:** The manufacturer assumes no responsibility for any damage caused by the work carried out by unauthorized persons.



**WARNING:** The product's power cable must be unplugged during installation. Failure to do so may result in death or serious injuries!



**WARNING:** If the door span is too narrow for the product to pass, remove the door and turn the product sideways; if this does not work, contact the authorized service.

- Place the product on a flat surface to avoid vibration.
- Place the product at least 30 cm away from the heater, stove and similar sources of heat and at least 5 cm away from electric ovens.
- Do not expose the product to direct sunlight or keep in damp environments.
- The product requires adequate air circulation to function efficiently.
- If the product will be placed in an alcove, remember to leave at least 5 cm distance between the product and the ceiling and the walls.
- Do not install the product in environments with temperatures below  $-5^{\circ}\text{C}$ .
- Your product requires adequate air circulation to function efficiently. If the product will be placed in an alcove, remember to leave at least 5 cm clearance between the product and the ceiling, rear wall and the side walls.

- If the product will be placed in an alcove, remember to leave at least 5 cm clearance between the product and the ceiling, rear wall and the side walls. Check if the rear wall clearance protection component is present at its location (if provided with the product). If the component is not available, or if it is lost or fallen, position the product so that at least 5 cm clearance shall be left between the rear surface of the product and the wall of the room. The clearance at the rear is important for efficient operation of the product.

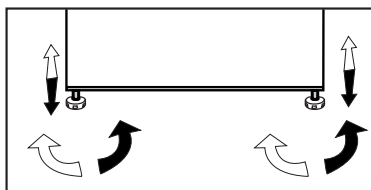

### 4.2. Adjusting the stands

If the product is not in balanced position, adjust the front adjustable stands by rotating right or left.



## Installation

### 4.3. Power connection

	<b>WARNING:</b> Do not use extension or multi sockets in power connection.
	<b>WARNING:</b> Damaged power cable must be replaced by Authorized Service.
	When placing two coolers in adjacent position, leave at least 4 cm distance between the two units.

- Our firm will not assume responsibility for any damages due to usage without earthing and power connection in compliance with national regulations.
- The power cable plug must be easily accessible after installation.
- Do not use multi-group plug with or without extension cable between the wall socket and the refrigerator.

#### **Hot Surface Warning!**

Side walls of your product is equipped with refrigerant pipes to improve the cooling system. Refrigerant with high temperatures may flow through these areas, resulting in hot surfaces on the side walls. This is normal and does not need any servicing. Please pay attention while touching these areas.



### 4.4 Attaching the plastic wedges

Use the plastic wedges in the provided with the product to provide sufficient space for air circulation between the product and the wall.

1. To attach the wedges, remove the screws on the product and use the screws provided with the wedges.

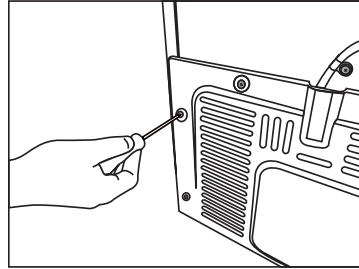

2. Attach 2 plastic wedges on the ventilation cover shown as j in the figure.

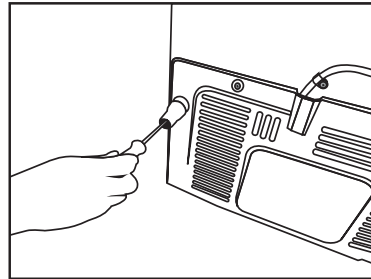

## 5 Preparation

 Read the “Safety Instructions” section first!

### 5.1. What to do for energy saving



Connecting the product to electronic energy-saving systems is harmful, as it may damage the product.

- Do not keep the refrigerator doors open for long periods.
- Do not place hot food or beverages into the refrigerator.
- Do not overfill the refrigerator; blocking the internal air flow will reduce cooling capacity.
- In order to store the maximum amount of food into the cooler compartment of your refrigerator, you should take out the upper drawers and place it onto the glass rack. The declared energy consumption of your refrigerator was determined by taking out the cooler, ice tray and upper drawers in a way that will enable maximum storage. Using the below drawer when storing is strongly recommended. Energy saving function should be activated for best energy consumption.
- You should not block the airflow by putting food in front of the cooler fan. A space of minimum 3cm must be left in front of the protective fan wire when placing food.
- Depending on the product's features; defrosting frozen foods in the cooler compartment will ensure energy saving and preserve food quality.
- Food should be stored using the drawers in the cooler compartment in order to ensure energy saving and protect food in better conditions.
- Food packages should not be in direct contact with the heat sensor located in the cooler compartment. If they

are in contact with the sensor, energy consumption of the appliance might increase.

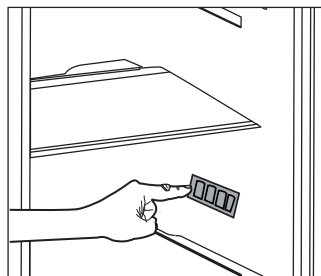

- Make sure the foods are not in contact with the cooler compartment temperature sensor described below.

### 5.2. First Use

Before using your refrigerator, make sure the necessary preparations are made in line with the instructions in “Safety and environment instructions” and “Installation” sections.

- Keep the product running with no food inside for 6 and do not open the door, unless absolutely necessary.



A sound will be heard when the compressor is engaged. It is normal to hear sound even when the compressor is inactive, due to the compressed liquids and gasses in the cooling system.



Front edges of the product might heat up. This is normal. These areas are designed to warm up in order to prevent condensation.



In some models indicator panel turns off automatically 5 minutes after the door closes. It will be reactivated when the door is open or any button is pressed.

## 5 Preparation

- Since hot and humid air will not directly penetrate into your product when the doors are not opened, your product will optimize itself in conditions sufficient to protect your food. Functions and components such as compressor, fan, heater, defrost, lighting, display and so on will operate according to the needs to consume minimum energy under these circumstances.

## 6 Using the product

### 6.1. Indicator panel

This touch-control indicator panel allows you to set the temperature without opening the door of your refrigerator. Just touch the relevant button with your finger to set the temperature.

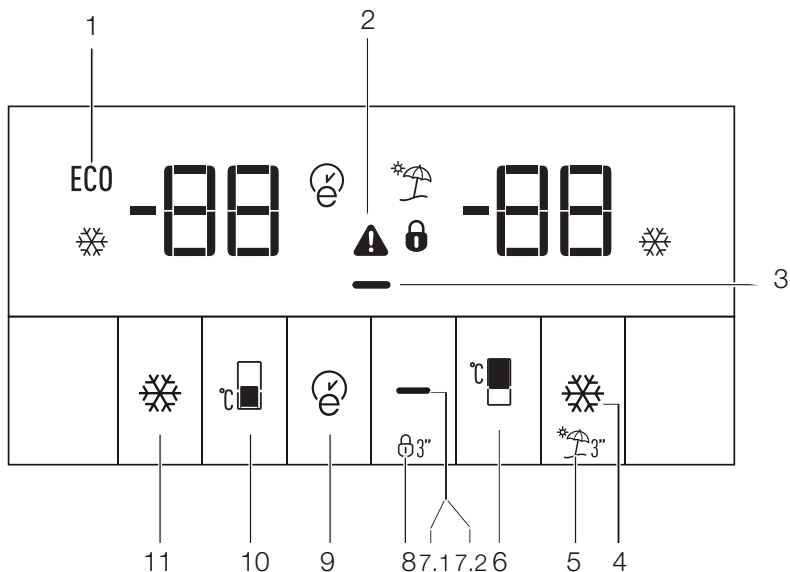

1. Economic use
2. High temperature / fault alert
3. Energy saving function (display off)
4. Rapid cooling
5. Vacation function
6. Cooler compartment temperature setting
7. Energy saving (display off) / Alarm off warning
8. Keypad lock
9. Eco-fuzzy
10. Freezer compartment temperature setting
11. Rapid freezing

**May not be available in all models**



**\*Optional:** The figures in this user guide are intended as drafts and may not perfectly match your product. If your product does not comprise the relevant parts, the information pertains to other models.

## Using the product

### 1. Economic use

#### **(May not be available in all models)**

This sign will light up when the freezer compartment is set to  $-18^{\circ}\text{C}$ , the most economical setting. (ECO) Economic use indicator will turn off when rapid cooling or rapid freezing function is selected.

### 2. Power Failure / High temperature / Error status indicator

This indicator (  ) illuminates in case of power failure, high temperature and error warnings. When the temperature of the freezer compartment is heated up to a critical level for the frozen food, the maximum value reached by the freezer compartment temperature flashes on the digital indicator. Check the food in the freezer compartment.

This is not a malfunction. The warning may be deleted by pressing any button or on high temperature alarm off button. (Cancelling by pressing any button is not applicable for every model.)

This indicator (  ) illuminated when a sensor failure occurs, too. When this indicator is illuminated, "E" and figures such as "1,2,3..." are displayed alternatively on the temperature indicator. These figures on the indicator inform the service personnel about the error.

### 3. Energy saving function (display off)

#### **(May not be available in all models)**



If the product doors are kept closed for a long time energy saving function is automatically activated and energy saving symbol is illuminated. When energy saving function is activated, all symbols on the display other than energy saving symbol will turn off. When the Energy Saving function is activated, if any button is pressed or the door is opened, energy saving function will be cancelled and the symbols on display will return to normal.

Energy saving function is activated during delivery from factory and cannot be cancelled.

### 4. Rapid cooling

When the rapid cooling function is turned on, the rapid cool indicator will light up (  ) and the cooler compartment temperature indicator will display the value 1. Push the Rapid cool button again to cancel this function. The Rapid cool indicator will turn off and return to normal setting. The rapid cooling function will be automatically cancelled after 1 hour, unless cancelled by the user. Too cool a large amount of fresh food, press the rapid cool button before placing the food in the cooler compartment.

### 5. Vacation function

To activate the Vacation function, press the button for (  ) 3 seconds; this will activate the vacation mode indicator (  ). When the Vacation function is active, the cooler compartment temperature indicator displays the inscription "--" and no cooling process will be active in the cooling compartment. This function is not suitable to keep food in the cooler compartment. Other compartments will remain cooled with the respective temperature set for each compartment.

Push the **vacation function** button again to cancel this function



### 6. Cooler compartment temperature setting

After pressing the button, the cooler compartment temperature can be set to 8,7,6,5,4,3,2 and 1 respectively. (  )



## Using the product

### 7.1. Energy saving (display off) (May not be available in all models)



Pressing this button (  ) will light up the energy saving sign (  ) and the Energy-saving function will activate. Activating the energy-saving function will turn off all other signs on the display. When the energy-saving function is active, pressing any button or opening the door will deactivate the energy-saving function and the display signals will return to normal. Pressing this button (  ) again will turn off the energy-saving sign and deactivate the energy-saving function.

### 7.2. Termination of the High Temperature Warning:

In case of power failure/high temperature warning, you may delete the warning (  ) by pressing any button on the indicator or high temperature alarm off button for 1 second after checking the food inside the freezer compartment.

Note: Cancelling by pressing any button is not applicable for every model.

### 8. Key lock

Press key lock button (  ) simultaneously for 3 seconds. Key lock symbol (  ) will light up and key lock mode will be activated. Buttons will not function if the Key lock mode is active. Press key lock button simultaneously for 3 seconds again. Key lock symbol will turn off and the key lock mode will be exited.

Press the **key lock** button if you want to prevent changing of the temperature setting of the refrigerator (  ).

### 9. Eco fuzzy

Press and hold eco fuzzy button for 1 seconds to activate eco fuzzy function. Refrigerator will start operating in the most economic mode at least 6 hours later and

the economic usage indicator will turn on when the function is active (  ). Press and hold eco fuzzy function button for 3 seconds to deactivate eco fuzzy function. This indicator is illuminated after 6 hours when eco fuzzy is activated.

### 10. Freezer compartment temperature setting

Temperature setting for freezer compartment is performed here. When button no. 9 is pressed, you may set the temperature of the freezer compartment to -18, -19, -20, -21, -22, -23 and -24 respectively.

### 11. Fast freeze

Press button no. (11) for fast freeze operation, quick freeze indicator (  ) shall be activated.

Quick freeze indicator is illuminated when quick freeze function is activated and fridge compartment temperature indicator is displayed as -27. To cancel this function press quick freeze button (  ) again. Quick freeze indicator will turn off and refrigerator will return to its normal settings. Quick freeze function is canceled automatically in 24 hour if you do not cancel it before. If you want to freeze large amounts of fresh food, press the quick freeze button before putting the food into the freezer compartment.

## Using the product

### 6.2. Ice bucket

#### **\*optional**

Take the ice bucket from the freezer compartment.

Fill the ice bucket with water.

Place the ice bucket into the freezer compartment.

The ice will be ready after approximately two hours. Take the ice bucket from the freezer compartment and bend in slightly over the holder that you are going to serve. Ice will easily pour into the serving holder.

### 6.3. Eggholder

You can put the eggholder on the door or body rack of your choice. If you decide to put it on the body rack, it is recommended to prefer the shelves below as they are colder.



Do not put the eggholder into the freezer compartment.

### 6.4. Fan

Fan was designed to distribute circulate the cold air inside your refrigerator homogeneously. Operating time of the fan might vary depending the features of your product.

While in some products fan only operates with compressor, in others control system determines the operating time based on the need for cooling.

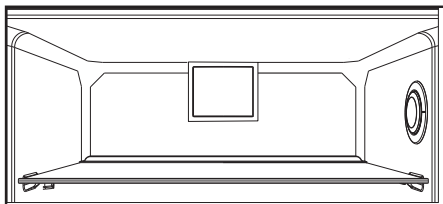

### 6.5. Vegetable bin

#### **\*optional**

Product's vegetable bin is designed to keep vegetables fresh by preserving humidity. For this purpose, the overall cold air circulation is intensified in the vegetable bin.

### 6.6. Using the second crisper of the product;



**Figure 1.**

As shown in the figure, there are 2 stoppers in the second crisper of K70560 model product.



**Figure 2.**

The second crisper looks like Figure 2 when closed.



**Figure 3.**

With the door is open 90°, pull the second crisper up to the first stopper as shown in Figure 3.

In the case that the drawer is more open, first of all, open the door by at least 135° degrees. After that, as shown in Figure 4, lift the second crisper for about 5 mm so that it is freed from the first stopper.



**Figure 4.**

After lifting, pull the second drawer up to the second stopper as shown in Figure 5.



**Figure 5.**

## Using the product

### 6.7. Zero degree compartment

#### \*optional

Use this compartment to keep delicatessen at lower temperatures or meat products for immediate consumption.

Zero degree compartment is the coolest place where foods such as dairy products, meat, fish and chicken can be stored in ideal storage conditions. Vegetables and/or fruits should not be stored in this compartment.

### 6.8. Sliding storage box

#### \*optional

This accessory has been designed to increase the usage volume of the door racks.

Thanks to its ability to move sideways, it enables you to easily place long bottle, jar or boxes that you put in the bottle rack below.

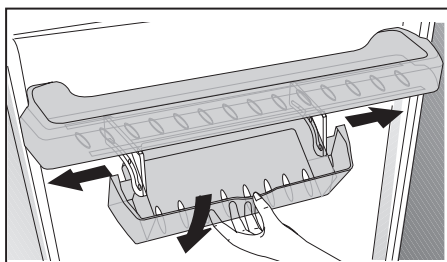

### 6.9. Moving door rack

#### \*optional

Moving door rack can be fixed in 3 different positions.

In order to move the rack, push the buttons on the side evenly. Rack will be movable.

Move the rack up or down.

When the rack is in the position that you want, release the buttons. Rack will be fixed again in the position where you have released the buttons.

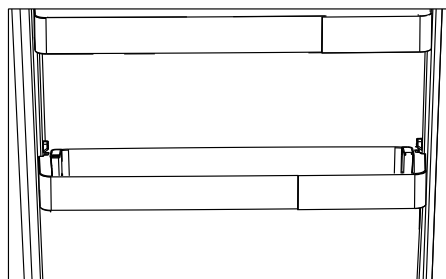
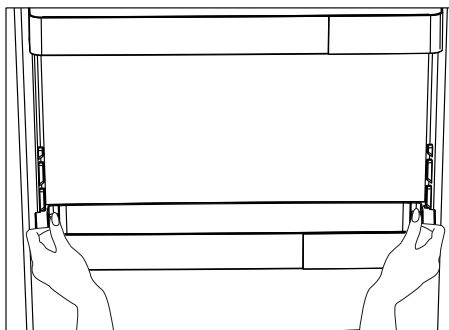

## Using the product

### 6.10. Moisture controlled vegetable bin

#### \*optional

With moisture control feature, moisture rates of vegetables and fruits are kept under control and ensures a longer freshness period for foods.

It is recommended to store leafed vegetables such as lettuce and spinach and similar vegetables prone to moisture loss not on their roots but in horizontal position into the vegetable bin as much as possible.

When placing the vegetables, place heavy and hard vegetables at the bottom and light and soft ones on the top, taking into account the specific weights of vegetables.

Do not leave vegetables in the vegetable bin in plastic bags. Leaving them in plastic bags causes vegetables to rot in a short time. In situations where contact with other vegetables is not preferred, use packaging materials such as paper that has a certain porosity in terms of hygiene.

Do not put fruits that have a high ethylene gas production such as pear, apricot, peach and particularly apple in the same vegetable bin with other vegetables and fruits. The ethylene gas coming out of these fruits might cause other vegetables and fruits to mature faster and rot in a shorter period of time.

### 6.11. Deodoriser Module (OdourFresh +) \*optional

Thanks to this module positioned on the ceiling of the fresh food compartment; the cleaned air can re-enter the air circulation, while the air is actively passed over the titanium dioxide-coated photocatalytic filter. In this way, bad odours are removed from the interior of the refrigerator before becoming permeated with the food surfaces, and at the same time, a hygienic air circulation is achieved via disinfected air. This is achieved thanks to the fan, UV-A LED and the titanium dioxide-coated odour filter located into the module on the ceiling. The photocatalytic module shall be automatically activated periodically. If the door of the fresh food compartment is opened while the module is active, the fan and UV-A LED will not operate temporarily, but will resume operation once the door is closed. In case of a power outage while the module is running, the module will resume operation from the point it stopped once the power is restored.

Note: To prevent bad odours that may occur with the mixture of odours from different types of food, we recommend you to store aromatic food such as cheese, olives and delicatessen in their packaging and with their lids closed. For the safety of other food stored, hygienic storage conditions and to prevent bad odours, we recommend you to remove the food that you have observed to be spoilt from the refrigerator as soon as possible.

## Using the product

### 6.12. Automatic ice machine

#### \*optional

Automatic ice machine enables you to easily make ice in your refrigerator. In order to obtain ice from the ice machine, take out the water tank in the cooler compartment, fill it with water and fix it back.

First ice will be ready in about 2 hours in the ice machine drawer in the cooler compartment.

After placing the full water tank, you can obtain about 60-70 cubes of ice until it is fully empty.

If the water in the tank has waited for 2-3 weeks, it should be changed.



In products with automatic ice machine, you might hear a sound when pouring the ice. This sound is normal and is not a sign of failure.

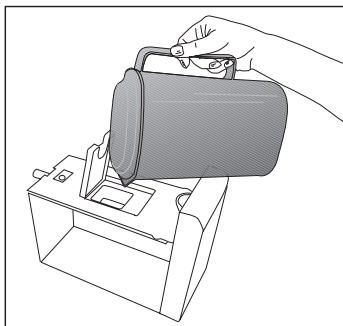
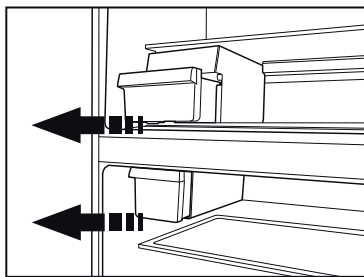

## Using the product

### 6.13. Icematic and ice storage container

#### \*optional

#### Using the Icematic

Fill the Icematic with water and place it into its seat. Your ice will be ready approximately in two hours. Do not remove the Icematic from its seating to take ice.

Turn the knobs on the ice reservoirs clockwise by 90 degrees.

Ice cubes in the reservoirs will fall down into the ice storage container below.

You may take out the ice storage container and serve the ice cubes.

If you wish, you may keep the ice cubes in the ice storage container.

#### Ice storage container

Ice storage container is only intended for accumulating the ice cubes. Do not put water in it. Otherwise, it will break.

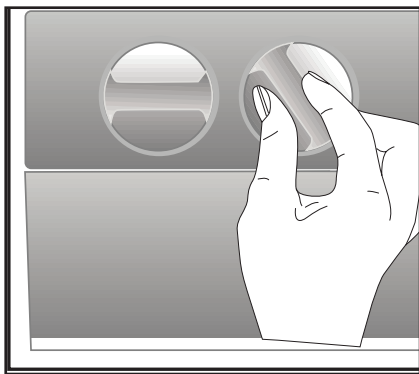

### 6.14. Ice bucket

#### \*optional

- Take the ice bucket from the freezer compartment.
- Fill the ice bucket with water.
- Place the ice bucket into the freezer compartment.
- The ice will be ready after approximately two hours. Take the ice bucket from the freezer compartment and bend in slightly over the holder that you are going to serve. Ice will easily pour into the serving holder.

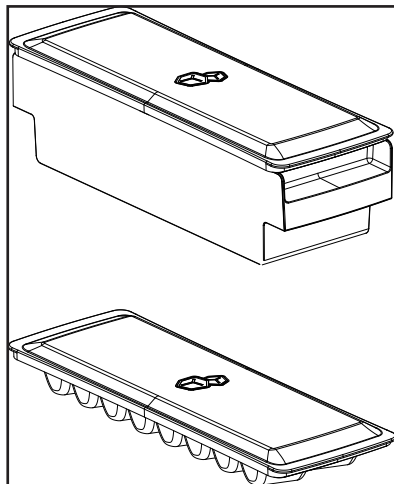

## Using the product

### 6.15. Using the water dispenser

#### \*optional

**i** It is normal for the first few glasses of water taken from the dispenser to be warm.

**i** If the water dispenser is not used for a long period of time, dispose of first few glasses of water to obtain fresh water.

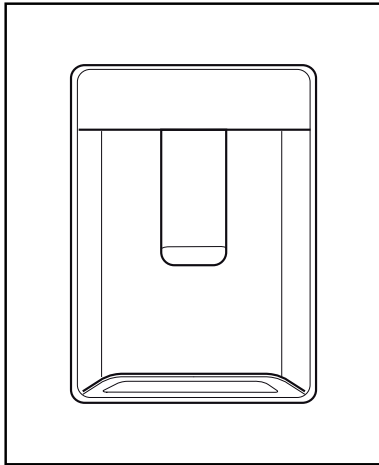

1. Push in the lever of the water dispenser with your glass. If you are using a soft plastic cup, pushing the lever with your hand will be easier.
2. After filling the cup up to the level you want, release the lever.

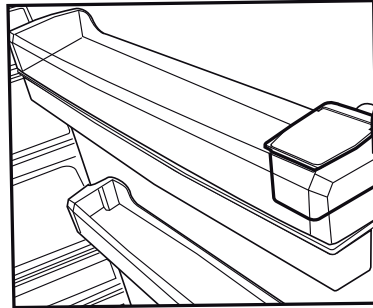



## Using the product

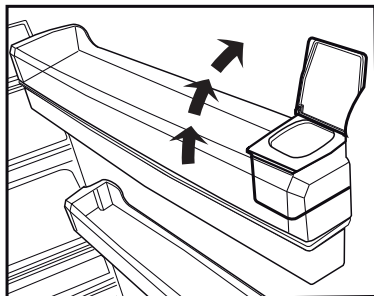

- i** Please note, how much water flows from the dispenser depends on how far you depress the lever. As the level of water in your cup / glass rises, gently reduce the amount of pressure on the lever to avoid overflow. If you slightly press the arm, the water will drip; this is quite normal and not a failure.

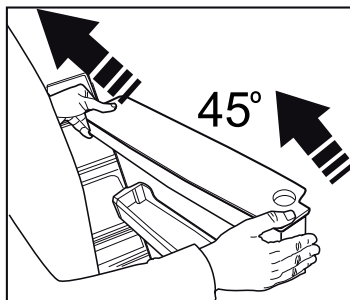
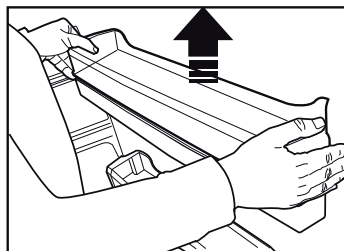

- i** Do not fill the water tank with any other liquid except for water such as fruit juices, carbonated beverages or alcoholic drinks which are not suitable to use in the water dispenser. Water dispenser will be irreparably damaged if these kinds of liquids are used. Warranty does not cover such usages. Some chemical substances and additives contained in these kinds of drinks/liquids may damage the water tank.

- i** Use clean drinking water only.

- i** Capacity of the water tank is 3 litres; do not overfill.

### 6.16. Filling the water dispenser's tank

Water tank filling reservoir is located inside the door rack.

1. Open the cover of the tank.
2. Fill the tank with fresh drinking water.
3. Close the cover.

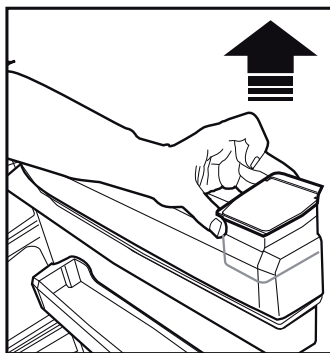

## Using the product

### 6.17. Cleaning the water tank

1. Remove the water filling reservoir inside the door rack.
2. Remove the door rack by holding from both sides.
3. Grab the water tank from both sides and remove it with an angle of 45°C.
4. Remove the cover of the water tank and clean the tank.



Components of the water tank and water dispenser should not be washed in dishwasher.

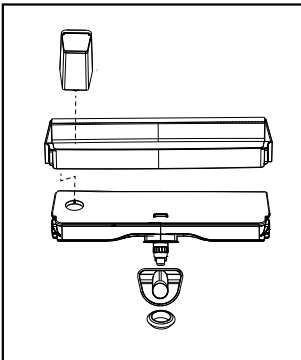
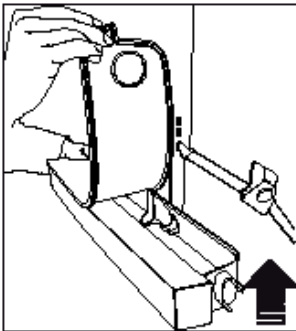

### 6.18. Drip tray

Water that dripped while using the water dispenser accumulates in the spillage tray.

Remove the plastic filter as shown in the figure.

With a clean and dry cloth, remove the water that has accumulated.

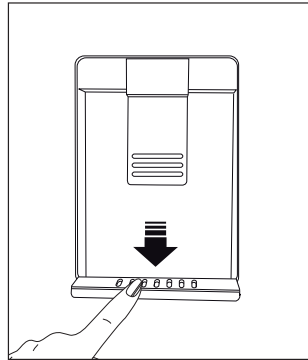

### 6.19. HerbBox/HerbFresh

Remove the film container from HerbBox/HerbFresh+

Take the film out of the bag and put it into the film container as shown in the image.

Seal the container again and replace it into HerbBox/HerbFresh+ unit.

HerbBox–HerbFresh+ sections are especially ideal for storage of various herbs that are supposed to be kept in delicate conditions. You can store your unbagged herbs (parsley, dill, etc.) in this section horizontally and keep them fresh for a much longer period.

The film shall be replaced in every six months.

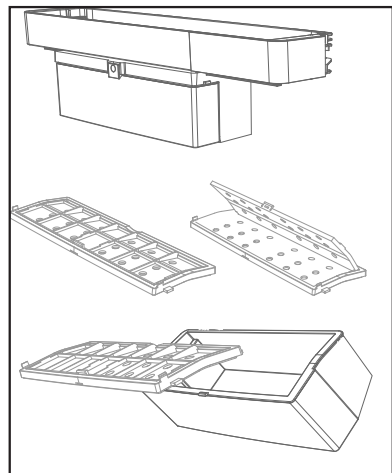

## Using the product

### 6.20. Freezing fresh food

- To preserve food quality, the food items placed in the freezer compartment must be frozen as quickly as possible, use the rapid freezing for this.
- Freezing the food items when fresh will extend the storage time in the freezer compartment.
- Pack the food items in air-tight packs and seal tightly.
- Make sure the food items are packed before putting in the freezer. Use freezer holders, tinfoil and damp-proof paper, plastic bag or similar packaging materials instead of traditional packaging paper.



Ice in the freezing compartment thaws automatically.

- Mark each food pack by writing the date on the package before freezing. This will allow you to determine the freshness of each pack every time the freezer is opened. Keep the earlier food items in the front to ensure they are used first.
- Frozen food items must be used immediately after defrosting and should not be frozen again.
- Do not freeze large quantities of food at once.

### 6.21. Recommendations for storing frozen foods

The compartment must be set to at least  $-18^{\circ}\text{C}$ .

1. Place the food items in the freezer as quickly as possible to avoid defrosting.
2. Before freezing, check the "Expiry Date" on the package to make sure it is not expired.

Freezer Compartment Temperature Setting	Cooler Compartment Temperature Setting	Details
$-18^{\circ}\text{C}$	$4^{\circ}\text{C}$	This is the default, recommended setting.
$-20^{\circ}\text{C}$ , $-22^{\circ}\text{C}$ or $-24^{\circ}\text{C}$	$4^{\circ}\text{C}$	These settings are recommended for ambient temperatures exceeding $30^{\circ}\text{C}$ .
Quick Freeze	$4^{\circ}\text{C}$	Use when you want to freeze your food in a short time. When the process ends, the product will regain its position.
$-18^{\circ}\text{C}$ or colder	$2^{\circ}\text{C}$	Use these settings if you believe the cooler compartment is not cold enough due to ambient temperature or frequently opening the door.

## Using the product

3. Make sure the food's packaging is not damaged.

### 6.22. Deep freezer details

As per the IEC 62552 standards, the freezer must have the capacity to freeze 4,5 kg of food items at  $-18^{\circ}\text{C}$  or lower temperatures in 24 hours for each 100 litres of freezer compartment volume.

Food items can only be preserved for extended periods at or below temperature of  $-18^{\circ}\text{C}$ .

You can keep the foods fresh for months (in deep freezer at or below temperatures of  $18^{\circ}\text{C}$ ).

The food items to be frozen must not contact the already-frozen food inside to avoid partial defrosting.

Boil the vegetables and filter the water to extend the frozen storage time. Place the food in air-tight packages after filtering and place in the freezer. Bananas, tomatoes, lettuce, celery, boiled eggs, potatoes and similar food items should not be frozen. In case this food rots, only nutritional values and eating qualities will be negatively affected. A rotting threatening human health is not in question.

### 6.23. Placing the food

Freezer compartment shelves	Various frozen goods including meat, fish, ice cream, vegetables etc.
Cooler compartment shelves	Food items inside pots, capped plate and capped cases, eggs (in capped case)

Cooler compartment door shelves	Small and packed food or beverages
Vegetable bin	Fruits and vegetables
Fresh food compartment	Delicatessen (breakfast food, meat products to be consumed in short notice)

### 6.24. Door open alert

#### (Optional)

An audible alert will be heard if the product's door remains open for at least 1 minute. The audible alert will stop when the door is closed or any button on the display (if available) is pressed.

Door open alert is indicated to the user both audibly and visually. Interior lighting will turn off if the warning continues for 10 min.

### 6.25. Changing the opening direction of the door

You can change the direction of opening of your refrigerator depending on the location where you use it. When you need this, consult the closest Authorized Service.

The explanation above is a general statement. You should check the warning tag located inside the product package about the changeability of direction of the door.

### 6.26. Interior light

Interior light uses a LED type lamp. Contact the authorized service for any problems with this lamp. Lamp(s) used in this appliance cannot be used for house lighting. Intended use of this lamp is to help the user place food into the refrigerator / freezer safely and comfortably.

## Using the product

### 6.27. Blue light/VitaminZone

**\*May not be available in all models**

#### **For the blue light,**

Fruits and vegetables stored in the crispers that are illuminated with a blue light continue their photosynthesis by means of the wavelength effect of blue light and thus preserve their vitamin content.

#### **For VitaminZone,**

Fruits and vegetables stored in crispers illuminated with the VitaminZone technology preserve their vitamins for a longer time thanks to the blue, green, red lights and dark cycles, which simulate a day cycle.

If you open the door of the refrigerator during the dark period of the VitaminZone technology, the refrigerator will automatically detect this and enable the blue-green or red light to illuminate the crisper for your convenience. After you have closed the door of the refrigerator, the dark period will continue, representing the night time in a day cycle.

Service life of the product will extend and frequently encountered problems will decrease if the product is cleaned periodically.



**WARNING:** Switch off the product before cleaning.



**WARNING:** It is recommended to clean the condenser every six months using gloves. You must not use vacuum cleaners.

- Never use gasoline, benzene or similar substances for cleaning purposes.
- Never use any sharp abrasive instruments, soap, household cleaners, detergent or wax polish for cleaning.
- Dissolve one teaspoon of carbonate in half liter of water. Soak a cloth in the solution and wring it thoroughly. Wipe the interior of the refrigerator with this cloth and the dry thoroughly.
- Make sure that no water enters the lamp housing or other electrical parts.
- If you will not use the refrigerator for a long time, unplug it, remove all food inside, clean it and leave the door ajar.
- Check regularly that the door gaskets are clean. If not, clean them.
- Take out all items in the product to remove the door and body shelves.
- Remove the door shelves by pulling them up. Slide the shelves downwards to re-install them after cleaning.
- Never use chloric cleaning agents or water to clean outer surfaces or chrome-coated parts of the product. Chlorine causes abrasion on such metal surfaces.
- For non-No Frost products, water drops and frosting up to a fingerbreadth occur on the rear wall of the Fridge compartment. Do not clean it; never apply oil or similar agents on it.
- Only use slightly damp microfiber cloths to clean the outer surface of the product. Sponges and other types of cleaning cloths may scratch the surface.

### 7.1.Avoiding Bad Odours

Materials that may cause odour are not used in the production of our refrigerators. However, odour may be emitted if foods are stored improperly or if the inner surface of the product is not cleaned as required. Please consider the following to avoid this problem:

- It is important that the refrigerator is kept clean. Food residuals, stains, etc. can cause odour. For this reason, clean your refrigerator with carbonate solved in water every 15 days. Never use detergents or soap.
- Keep your foods in closed vessels. Microorganisms emitted from vessels without a cover may cause unpleasant odours.
- Never keep expired or spoiled foods in your refrigerator.

### 7.2.Protection of plastic surfaces

Do not put liquid oils or oil-cooked meals in your refrigerator in unsealed containers as they damage the plastic surfaces of your refrigerator. If oil is spilled or smeared onto the plastic surfaces, clean and rinse the relevant part of the surface with warm water immediately.

### 7.3.Cleaning the Inner Surface

To clean the inner surfaces and all removable parts, wash them with a mild solution comprising soap, water and carbonate. Rinse and dry thoroughly. Prevent the water from contacting the lighting means and control panel.

## 7 Care and Cleaning



### **ATTENTION:**

Do not use vinegar, rubbing alcohol or other alcohol-based cleaning agents on any of the inner surfaces.

### **7.4 Stainless Steel Outer Surfaces**

Use a stainless steel cleaning agent that is non-abrasive and apply it with a lint-free, soft cloth. For polishing, wipe the surface softly with a damp microfiber cloth and use dry wash-leather. Always follow the strands of the stainless steel.

### **7.5.Cleaning Products with Glass Doors**

Remove the protection foil on the glass. There is a coating on the surface of the glass. This coating minimises stain formation and ensures that stains and dirt are cleaned easily. Glasses that are not protected by a coating might be exposed to permanent bonding of organic or inorganic, air or waterborne pollutants such as limescale, mineral salts, unburned hydrocarbons, metal oxides and silicons, which lead to stains and physical damage in a short time. Despite regular washing, the glass becomes very hard to keep clean, though not impossible. As a result, the clarity and good appearance of the glass reduces. Hard and abrasive cleaning compounds and methods increase these defects even further and accelerate the deterioration process. \*Non-alkali, non-abrasive and water-based cleaning products must be used for routing cleaning procedures.

For the coating to have long service life, alkali or abrasive substances must not be used during cleaning processes.

These glasses were subject to a tempering process to increase their impact and breakage resistance.

As an additional safety measure, there is a safety film on the back surfaces of the glasses to ensure that they will not harm the environment in case of breakage.

Please review this list before calling the service. This will save you time and money. This list contains frequently encountered problems that are not results of faulty workmanship or material use. Your product may not have some of the features described here.

### The refrigerator is not operating.

- It may not be plugged in properly. >>>Plug in the product properly.
- The fuse of the socket to which your refrigerator is connected or the main fuse may have blown. >>>Check the fuse.

### Condensation on the side wall of the fridge compartment (MULTI ZONE, COOL CONTROL and FLEXI ZONE).

- The door may have been opened/closed frequently. >>>Do not open/close the refrigerator door frequently.
- The environment may be too humid. >>>Do not install the refrigerator at locations with a very high level of humidity.
- Foods containing liquid may have been placed into the refrigerator in vessels without covers. >>>Do not place foods containing liquid into the refrigerator in unsealed vessels.
- Door of the refrigerator may have been left ajar. >>>Do not keep the doors of your refrigerator open for a long time.
- The thermostat may have been set to a very cold level. >>>Set the thermostat to an appropriate level.

### The compressor is not operating.

- Protective thermal of the compressor will blow out during sudden power failures or plug-out plug-ins as the refrigerant pressure in the cooling system of the refrigerator has not been balanced yet. The refrigerator will start running approximately after 6 minutes. Please call the Authorised Service Provider if the refrigerator does not start at the end of this period.
- The freezer is in defrosting cycle. >>>This is normal for a refrigerator that performs full-automatic defrosting. Defrosting cycle is performed periodically.
- The refrigerator may not be plugged in. >>>Make sure that the plug fits the socket.
- Temperature settings may be incorrect. >>>Select the correct temperature value.
- Possible power failure. >>>The refrigerator will start to operate normally when power restores.

### The operation noise increases when the refrigerator is running.

- Operating performance of the refrigerator may vary based on the ambient temperature changes. This is normal and not a fault.

### The fridge is running frequently or for a long time.



## Troubleshooting

- Your new product may be bigger than the previous one. Larger refrigerators operate for a longer period of time.
- The room temperature may be high. >>> It is normal that the product operates for longer periods in hot environments.
- The refrigerator may have just been plugged in or loaded with food. >>> It takes the product longer to reach the set temperature when it has just been plugged in or loaded with food. This is normal.
- Large amounts of hot food may have been placed into the refrigerator recently. >>> Do not place hot foods into the refrigerator.
- The doors may have been opened frequently or left ajar for a long time. >>> The warm air that enters the refrigerator causes it to operate for a longer period of time. Do not open the doors frequently.
- Freezer or fridge compartment door may have been left ajar. >>> Check if the doors are closed completely.
- The appliance may be set to a very low temperature. >>> Set the refrigerator temperature to a warmer degree and wait until the product reaches this temperature.
- Door seal of the fridge or freezer compartment may be soiled, worn out, broken or not properly seated. >>> Clean or replace the seal. Damaged/broken seal causes the refrigerator to run for a longer period of time to maintain the current temperature.

### **Fridge temperature is adequate but the freezer temperature is very low.**

- The freezer compartment temperature may be set to a very low value. >>> Set the freezer compartment temperature to a higher value and check.

### **Freezer temperature is adequate but the fridge temperature is very low.**

- The fridge temperature is adjusted to a very low value. >>> Adjust the fridge temperature to a higher value and check.

### **Food kept in the fridge compartment drawers is frozen.**

- The fridge compartment temperature may be set to a very high value. >>> Set the fridge compartment temperature to a lower value and check.

### **Temperature in the fridge or freezer is very high.**

- The fridge compartment temperature may be set to a very high value. >>> Fridge compartment temperature setting has an effect on the temperature of the freezer. Change the temperature of the fridge or freezer compartment until the fridge or freezer compartment temperature reaches an adequate level.
- The doors may have been opened frequently or left ajar for a long time. >>> Do not open the doors frequently.
- The door may have been left ajar. >>> Close the door completely.
- The refrigerator may have been just plugged in or loaded with food. >>> This is normal. It takes the product longer to reach the set temperature when it has just been plugged in or loaded with food.
- Large amounts of hot food may have been placed into the refrigerator recently. >>> Do not place hot foods into the refrigerator.

### **Vibration or noise.**

- The floor may not be stable or level. >>> If the refrigerator shakes when moved slightly, adjust the feet to balance it. Make sure that the floor is level and capable of carrying the refrigerator.
- Objects placed onto the refrigerator may cause noise. >>> Remove the objects on the refrigerator.

# Troubleshooting

## **There are noises coming from the refrigerator like liquid spilling or spraying.**

- Liquid and gas flows occur in accordance with the operating principles of the refrigerator. >>>This is normal and not a fault.

## **Whistle is heard from the refrigerator.**

- There are fans that are used to cool the refrigerator. This is normal and not a fault.

## **Damp accumulates on the inner walls of refrigerator.**

- Hot and humid weather increases icing and condensation. This is normal and not a fault.
- The doors may have been opened frequently or left ajar for a long time. >>>Do not open the doors frequently. Close the doors, if open.
- The door may have been left ajar. >>>Close the door completely.

## **Humidity occurs on the outer surface of the refrigerator or between the doors.**

- Air might be humid. This is quite normal in humid weathers. >>>Condensation will disappear when the humidity level decreases.
- There might be external condensation at the section between two doors of the refrigerator if you use your product rarely. This is normal. Condensation will disappear upon frequent use.

## **There is a bad odour inside the refrigerator.**

- No regular cleaning may have been performed. Clean the inside of the refrigerator with a sponge, lukewarm water or carbonated water.
- Some vessels or packaging materials may cause the odour. >>>Use another vessel, or packaging materials from another brand.
- Foods may have been placed into the refrigerator in vessels without covers. >>>Store the foods in closed vessels. Microorganisms emitted from vessels without a cover may cause unpleasant odours.
- Take out expired or spoiled foods from the refrigerator.

## **The door cannot be closed.**

- Food packages may be preventing the door from closing. >>> Re-locate the packages that are obstructing the door.
- The refrigerator may be unstable on the floor. >>>Adjust the refrigerator feet as required to keep the refrigerator in balance.
- The floor may not be level or solid. >>>Make sure that the floor is level and capable of carrying the refrigerator.

## **Crispers are stuck.**

- Foods may be touching the upper wall of the crisper. >>>Re-organise the foods in the crisper.

## **If The Surface Of The Product Is Hot.**

High temperatures may be observed between the two doors, on the side panels and at the rear grill while the product is operating. This is normal and does not require service maintenance!

## **Fan keeps running when the door is open.**

The fan may keep running when the door of the freezer is open.



**WARNING:** If you cannot eliminate the problem although you follow the instructions in this section, consult your dealer or the Authorised Service Provider. Never attempt to repair a malfunctioned product.

## **DISCLAIMER/WARNING**

Some (simple) malfunctions may be repaired by end users without creating any safety issue or causing unsafe usage provided that they are carried out under the following instructions.

(Please see the section "I Want to Repair Myself".)

For this reason, except for parts specified at the section "I Want to Repair Myself" as could be repaired by end users, repair by an authorized service station is definitely suggested for the purpose of preventing any safety issues and this is required so that Arçelik product warranty may continue.

## **I WANT TO REPAIR MYSELF**

Repair that will be carried out by end users can be performed within the following spare parts: Door Handles and Door Hinges, Door Joints and peripheral Trays, Baskets, Racks. (You may have access to current list of spare parts from <https://www.arcelik.com.tr/destek> as of 1 March 2021)

Further, in order to ensure product safety and to prevent risk of severe injuries, repair has to be carried out according to instructions from user manual or <https://www.arcelik.com.tr/destek>. For your own safety, please unplug product prior to carrying out any repair.

Arçelik may not be held responsible for safety issues that may arise because of repairs or attempts not carried out in accordance with instructions specified at user manuals or located at <https://www.arcelik.com.tr/destek> and performed on parts other than parts contained at current list of parts accessed from <https://www.arcelik.com.tr/destek>. In such a case, Arçelik product warranty will be invalid.

For this reason, we strongly recommend end users to avoid carrying out repairs for parts other than above-mentioned spare parts themselves and apply to an authorized service station in case of requirement. Such repair attempts by end users may cause safety issues, may damage product and may cause fire, flood, electrocution and severe personal injuries afterwards.

Including but not limited to the listed items, repairs of the following parts have to be performed by authorized service stations: Compressor, Cooling system elements, Motherboard, Inverter card, Display card, etc.

Manufacturer/dealer may not be held responsible for any circumstances where end users fail to act in accordance with the foregoing.

This product is equipped with a lighting source of the "G" energy class.

The lighting source in this product shall only be replaced by professional repairers.